

Typical Wiring Schematic

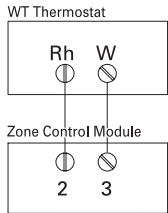

Fig 1: Typical hook up using Zone Control Module

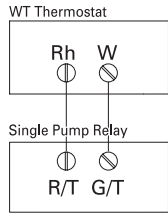

Fig 2: Typical hook up using Single Pump Relay

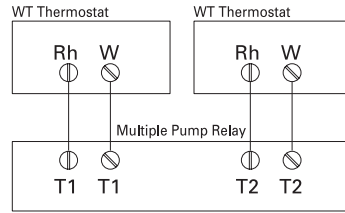

Fig 3: Typical hook up using Multiple Pump Relay

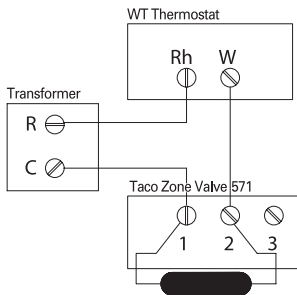

Fig 4: Typical hook up using Taco 571 Zone Valve

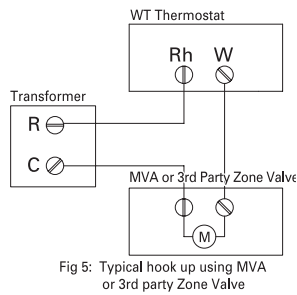

Fig 5: Typical hook up using MVA or 3rd party Zone Valve

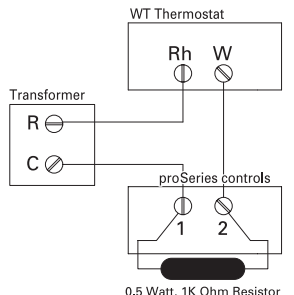

Fig 6: Typical hook up using proSERIES controls

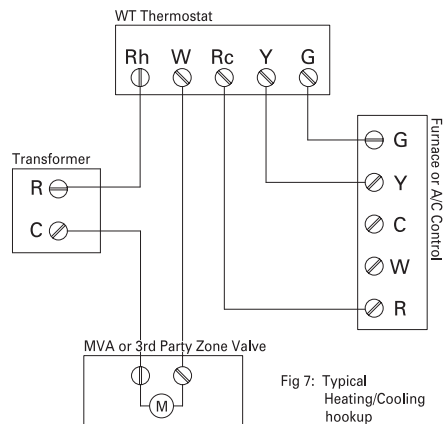

Fig 7: Typical Heating/Cooling hook up

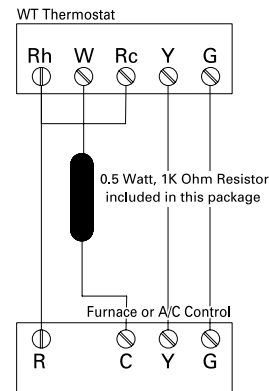

Fig 8: Typical hook up using Cooling Only

WIRSBO®
Life, Safety, Comfort Systems

THERMOSTATS for Radiant Heating



APPLICATION

Wirsbo Thermostats are the first digital thermostats designed specifically for use in hydronic radiant heating applications. Wirsbo provides 2 models of thermostats;

- A3030101 – Heat only
- A3030102 – Heat/Cool

DEFINITION

The Wirsbo Thermostats are parasitic, or power-stealing thermostats. They are designed to operate in heating mode over two-wires. The thermostat gets its power for operation from "stealing" voltage off of the connected wiring. This eliminates any need for a third wire or batteries, which makes it simple to install, wire and service.

NOTE: The Wirsbo Thermostats are designed and tested to work effortlessly with other Wirsbo Components. Some commonly used third party control devices (relays, zone valves, etc.) have compatibility issues with power stealing thermostats in general. If the Wirsbo Thermostat is connected to a third party control device, please refer to the third party device operation and installation manual for specific instructions for installation with power stealing thermostats. For the most common applications, please review the schematics in this document. For additional help, please call our tech department @ **888-594-7726**.

SPECIFICATIONS

- **Operating Voltage** 24VAC +/-10%
- **Maximum Load** 1.3A @ 24VAC
(4 MVAs, p/n A3020522)
(6 TVAs, p/n A3010522)
- **Display Range** 32 to 99°F (0 to 37°C)
- **Setpoint Range** 40 to 99°F (4 to 37°C)
- **Resolution** 1° Displayed
0.25° Calculated
- **Temperature Ranges** 14 to 158°F, Shipping (-10 to 70°C)
32 to 104°F, Ambient (0 to 40°C)
- **Humidity** 40-90% non-condensing
- **Size** 5.0"H x 2.72"W x 0.91"D
- **Weight** 0.22 lbs.



TOOLS REQUIRED

- Small, flat heat screwdriver
- Phillips screwdriver (mounting hardware)
- Wire cutter/stripper

INSTALLATION

Prior to installing a Wirsbo Thermostat:

- a. Familiarize yourself with the product by reading the instructions. Failure to do so could result in damage to this product, yourself or create a potentially hazardous situation.
- b. Make sure that the function and rating of this product are suitable for the intended use.
- c. The installer must be an experienced, trained professional familiar with low voltage wiring
- d. Wirsbo recommends using 18AWG wiring for all low voltage wiring connections.

LOCATION

Thermostat placement is extremely important. Install Wirsbo Thermostats approximately 5 (five) feet above the floor on a smooth, flat surface. Avoid mounting the thermostat in the following locations:

- Near or around windows
- On outside walls
- Near fireplaces
- In the corner of a room
- Behind doors
- On interior walls susceptible to solar gains
- Near stoves, lamps, televisions, etc.
- Damp areas

MOUNTING THE WALLPLATE

To begin, separate the front and back plates of the thermostat. Wirsbo Thermostats are opened by applying gentle pressure downward on the front half and separating from the back. The thermostat case is designed to fit (and mount) directly to a standard electrical wall box or can be directly wall mounted on most surfaces using suitable hardware.



- Pull the thermostat wire through the round opening in the back plate.
- Place the backplate against the wall at the desired location in order to cover the open or electrical wall box. Make sure the round opening for the is in the lower half of the case.
- Align the holes of the backplate to the holes in the electrical wall box and attach using suitable hardware.
- If mounting on drywall, use wall anchors and screws (or other suitable material) and attach accordingly.
- If the wall cavity behind the thermostat is susceptible to drafts (return air plenum), plug and seal any openings to prevent them from affecting temperature reading.

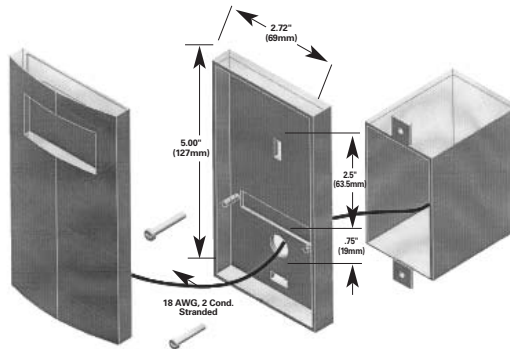

WIRING

All wiring must comply with local electrical code and specification.

Caution: Disconnect the electrical power to the system to prevent electrical shock.

- Remove 3/8" of wire insulation on the wire ends. Make sure the bared wires are clean and free of corrosion.
- Route the wires to the terminal block(s) and place the end of wires in the correct wiring location. (See section on wiring).
- Different from other power stealing thermostats, the heat terminals (Rh & W) are not polarity sensitive, essentially eliminating any potential of incorrectly wiring the thermostat.

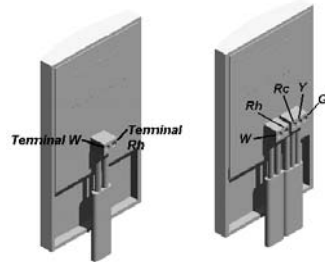

MOUNTING THE THERMOSTAT TO THE WALLPLATE

- Place the tabs at the bottom of the front enclosure into the grooves at the back of the wallplate.
- Check for alignment between the two components.
- Apply pressure to the top of the thermostat face until a "click" is heard.

WIRSBO
Life, Safety, Comfort Systems

SETTING AND ADJUSTING

Wirsbo Thermostats are designed to operate all functions with 2 buttons ("+" & "-") on the front of the thermostat case.

Power Up/Power Interruption — After all electrical connection are complete and the thermostat is properly mounted, power can be applied to the system. The thermostat defaults to a room set temperature of 68°F and the Heating mode of operation when the power is first applied. The thermostat will save the last temperature setting if power is interrupted.

Important: Both the Heat Only and Heat/Cool Thermostats will return to Heat Mode when power is shut off or interrupted

Normal Operation — The current room temperature measured by the thermostat is displayed during normal operation along with the mode of operation. The mode of operation is indicated on the display by the following icons:

- None** — Thermostat is turned off.
- Radiant Panel** — Heat mode, no call for heat
- Radiant Panel w/lines flashing above** — Heat mode, call for heat.



Figure 1: Thermostat display indicating call heat.

- Snowflake** — Cooling mode, no call for cooling (Heat/Cool model only)
- Flashing Snowflake** — Cooling mode, call for cooling (Heat/Cool model only)

Making the room warmer or cooler (Temperature Adjustment) — Pressing the + (increase) and - (decrease) buttons will change the desired room temperature setting.

- Press either button to enter the programming mode.
- The icon showing mode of operation will start to flash.
- Press the "+" button to increase the room temperature and "-" to lower the temperature. Press and hold the button to rapidly change the temperature setting.
- Any change is accepted 5 seconds after the last button is pressed and reverts to displaying the current room temperature.

Note: The room temperature setting cannot be adjusted when the mode is set to off.

Switching from Heating to Cooling (Mode Selection) — Wirsbo Thermostats do not require a switch to change the thermostat over from heating to cooling.

- Press both buttons simultaneously to change the mode of operation.
- Make sure the program bar is flashing to indicate you are in the programming mode.
- Press either button to change the mode of operation. Using the "+" button versus the "-" will only change the rotation sequence of the icons or modes.
- The mode of operation is indicated by the following icons:
 - None** — The thermostat is turned off
 - Floor Icon** — Heating Mode
 - Snowflake Icon** — Cooling Mode
- Any change is accepted 5 seconds after the last button is pressed and reverts to displaying the current room temperature. The program bar stops flashing and is shown as a solid bar.

Note: Fan operation is not active in this version of the Heat/Cool model.



Figure 2: Thermostat with all icons and segments displayed.

OPERATION

The dynamics of a radiant heating system differ from typical baseboard or warm air heating systems. Radiant systems always heat objects and mass and need to be addressed differently than conventional thermostat logic. The Wirsbo Thermostats have 2 different control methods to handle this condition:

- Differential** — When the measured room temperature falls 1°F (0.5°C) below the desired room setting, the control devices wired to the thermostat are turned on.

- Pulse Width Modulation (PWM)** — When the condition exists where the room temperature is 1-3°F (0.5-1.5°C) below the room setting, the thermostat manages the on and off cycle using PWM. The on and off times will vary depending on the difference between room and set temperature; the further away, the longer the on time. This prevents the room temperature from rising above the set temperature. The heating system will run continually at room temperature differences greater

than 3°. This is important to understand for this reason: When the thermostat is in PWM mode, the heating icon may be flashing but the heating equipment will be turned off.

- Digital Filtering** — Room temperature is measured continually using the WT series thermostats. Even the smallest change will be detected by the thermostat's sensor and is better able to react a room's changing conditions. If all of the room's temperatures were displayed as

they are sensed, the temperatures shown would appear erratic and inconsistent. By filtering, or throwing out the values that do not make sense, the display and operation becomes smoother.

Note: Room temperatures can take up to a minute to change 1°F (0.5°C) due to filtering.

IMPORTANT

- This product is not designed to use with heating on forced air furnaces.
- Thermostats conform to universal industry standards. Wirsbo **IS NOT** responsible for damages resulting from misapplication or misuse of its products.
- Thermostats must be installed with the power supply disconnected. Failure to do so can result in damage to the thermostat.

Wirsbo Thermostats require minimum current to operate correctly. A 1,000V, 0.5W resistor is included in this package and may be required to make 3rd party devices operate. See the WIRING section for additional information.